

ELM822xA 1.5µA Very low power CMOS operational amplifier

<http://www.elm-tech.com>

■General description

ELM822xA is a very low current consumption-Typ.1.5µA CMOS OP-AMP provided with a wide common mode input voltage range. It has a quasi rail-to-rail input stage and a push-pull rail-to-rail output stage. ELM822xA can operate down to 1.2V. ELM824xA is suitable for portable devices which require low power and a single voltage source.

■Features

- Operation from a single power source
- Low voltage operation : $1.2V \leq V_{dd} \leq 6.0V$
- Low current consumption : Typ.1.5µA
- N-channel depletion differential input
 - : No gm dependence on input operating points
- Common-mode input voltage range
 - : Quasi rail-to-rail input
 - V_{ss} to $V_{dd}-0.3V$ ($V_{dd}=1.5V$)
 - V_{ss} to $V_{dd}-0.1V$ ($V_{dd}=3.0V$)
- Output stage : Push-pull rail-to-rail output
- Unity gain bandwidth : Typ.15kHz($V_{dd} \geq 1.5V$)
- Package : SOT-25, SC-70-5(SOT-353)

■Application

- Battery-operated portable devices
- Micropower signal process
- Low voltage analog circuit

■Maximum absolute ratings

Parameter	Symbol	Limit	Unit
Power supply voltage	V _{dd}	7.0	V
Input voltage	V _{in}	V _{ss} -0.3 to V _{dd} +0.3	V
Output voltage	V _{out}	V _{ss} -0.3 to V _{dd} +0.3	V
Output circuit		Continuous	Sec.
Power dissipation	P _d	300 (SOT-25)	mW
		150 (SC-70-5(SOT-353))	
Operating temperature	T _{op}	-40 to +85	°C
Storage temperature	T _{stg}	-55 to +125	°C

■Selection guide

ELM822xA-x

Symbol		
a	Package	B: SOT-25 C: SC-70-5(SOT-353)
b	Product version	A
c	Taping direction	S: Refer to PKG file N: Refer to PKG file

ELM822 x A - x
 ↑ ↑ ↑
 a b c

ELM822xA 1.5 μ A Very low power CMOS operational amplifier

<http://www.elm-tech.com>

■ Pin configuration

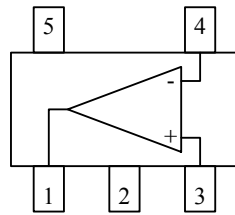

Pin No.	Pin name
1	OUT
2	VDD
3	IN+
4	IN-
5	VSS

■ Standard circuit

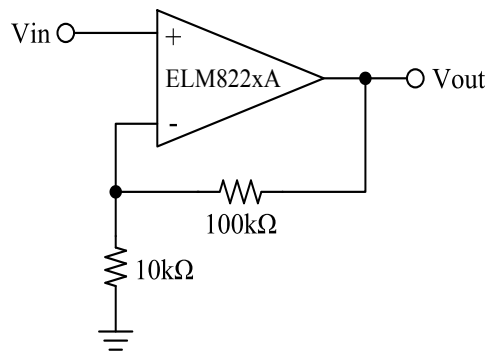

■ Marking

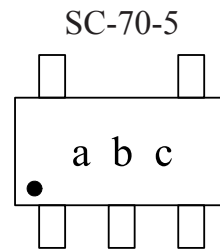
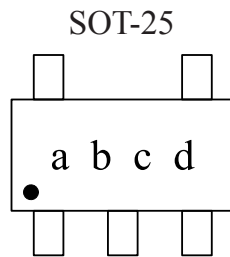

Symbol	Mark	Content
a, b	5 A	ELM822BA (SOT-25)
	> 0	ELM822CA (SC-70-5)
c	0 to 9 and A to Z (I, O, X excepted.)	Lot No.
d	0 to 9 and A to Z (I, O, X excepted.)	Lot No.

ELM822xA 1.5µA Very low power CMOS operational amplifier

<http://www.elm-tech.com>

■Electrical characteristics

V_{ss}=0V, Top=-40~+85°C

Parameter	Symbol	Condition	Min.	Typ.	Max.	Unit
Operating voltage	V _{dd}		1.2		6.0	V

V_{dd}=1.5V

V_{ss}=0V, Top=25°C

Parameter	Symbol	Condition	Min.	Typ.	Max.	Unit
Input offset voltage	V _{io}	V _{cm} =V _{dd} /2, Unity gain follower			±6	mV
Input bias current	I _{ib}				1.0	nA
Common-mode input voltage range	V _{cmr}	For CMRR≥45dB	0.00		1.20	V
Maximum output voltage swing	V _{outsh}	V _{id} =100mV, R _L =10kΩ to V _{ss}	1.40			V
Minimum output voltage swing	V _{outsl}	V _{id} =100mV, R _L =10kΩ to V _{dd}			0.10	V
Source current	I _{source}	V _{out} =1.2V, V _{id} =100mV	0.4	1.0		mA
Sink current	I _{sink}	V _{out} =0.3V, V _{id} =100mV	1.0	2.5		mA
Large-signal voltage gain	A _{vd}	R _L =100kΩ to V _{ss} , V _{cm} =0.75V		95		dB
Common-mode rejection ratio	CMRR	R _L =100kΩ to V _{ss} , V _{cm} =0.75V		85		dB
Supply voltage rejection ratio	PSRR	R _L =100kΩ to V _{ss} , V _{cm} =0.75V		95		dB
Current consumption	I _{ss}	V _{cm} =V _{dd} /2, Unity gain follower		1.5	3.8	µA
Short current	I _{shortp}	V _{out} to V _{ss} shrot, V _{id} =100mV		1.4		mA
	I _{shortn}	V _{out} to V _{dd} shrot, V _{id} =100mV		4.0		mA
Unity gain bandwidth	GBW			15		kHz
Slew rate	SR	R _L =100kΩ, C _L =20pF	7.0	14.0		mV/µs

V_{dd}=3.0V

V_{ss}=0V, Top=25°C

Parameter	Symbol	Condition	Min.	Typ.	Max.	Unit
Input offset voltage	V _{io}	V _{cm} =V _{dd} /2, Unity gain follower			±6	mV
Input bias current	I _{ib}				1.0	nA
Common-mode input voltage range	V _{cmr}	For CMRR≥45dB	0.00		2.90	V
Maximum output voltage swing	V _{outsh}	V _{id} =100mV, R _L =10kΩ to V _{ss}	2.90			V
Minimum output voltage swing	V _{outsl}	V _{id} =100mV, R _L =10kΩ to V _{dd}			0.10	V
Source current	I _{source}	V _{out} =2.7V, V _{id} =100mV	1.5	4.0		mA
Sink current	I _{sink}	V _{out} =0.3V, V _{id} =100mV	3.0	7.5		mA
Large-signal voltage gain	A _{vd}	R _L =100kΩ to V _{ss} , V _{cm} =1.5V		100		dB
Common-mode rejection ratio	CMRR	R _L =100kΩ to V _{ss} , V _{cm} =1.5V		90		dB
Supply voltage rejection ratio	PSRR	R _L =100kΩ to V _{ss} , V _{cm} =1.5V		100		dB
Current consumption	I _{ss}	V _{cm} =V _{dd} /2, Unity gain follower		1.5	3.8	µA
Short current	I _{shortp}	V _{out} to V _{ss} shrot, V _{id} =100mV		14		mA
	I _{shortn}	V _{out} to V _{dd} shrot, V _{id} =100mV		25		mA
Unity gain bandwidth	GBW			15		kHz
Slew rate	SR	R _L =100kΩ, C _L =20pF	7.5	14.5		mV/µs

ELM822xA 1.5 μ A Very low power CMOS operational amplifier

<http://www.elm-tech.com>

■Note

1) Common mode input voltage range

ELM822xA common mode input voltage range is fixed under the condition of $CMRR \geq 45dB$; ELM822xA is able to accept the input above its specification if the degradation of CMRR is not considered. Even if the input voltage exceeds either positive or negative power voltage, troubles such as reverse of output will not occur.

As maximum absolute rating, the input voltage is possible within $(V_{ss}-0.3)V$ to $(V_{dd}+0.3)V$.

2) Operation from single power source

ELM822xA is designed to be most suitable for single power source; therefore, ELM822xA is able to share power supply with logic circuit one. Meanwhile, ELM822xA can also operate from double power sources. To protect power supplies of ELM822xA and logic circuit from noise, please separate wire from power supply and use decoupling (bypass) capacitor. Using the capacitor can improve PSRR characteristics, especially on 10kHz to 100kHz or more.

3) Feedback

When OP-AMP circuit is used with feedback resistor, oscillation may happen in the circuit with loop-gain like unity gain follower.

a) When large feedback resistance is used, the phase margin is decreased by its combination with the parasitic capacitance of the input part of OP-AMP. In this situation, please connect small capacitor in parallel with feedback resistor as shown in fig-1.

b) For capacitive load, external resistor in series connection will be effective as shown in fig-2.
($R_L=300$ to 500Ω)

c) Being used as an unity gain follow, ELM822xA is able to drive capacitive load of 100pF directly without oscillation.

a) fig-1

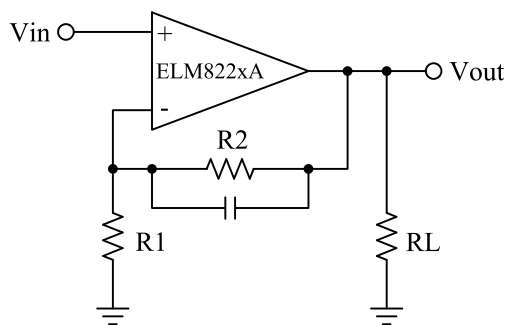

b) fig-2

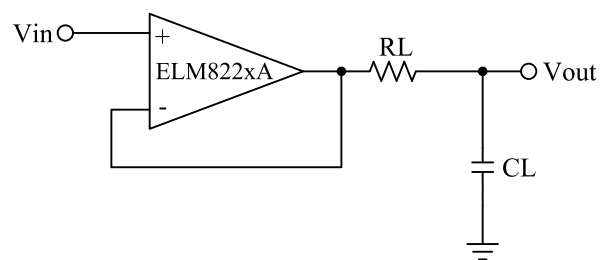

ELM822xA 1.5 μ A Very low power CMOS operational amplifier

<http://www.elm-tech.com>

■ Typical characteristics

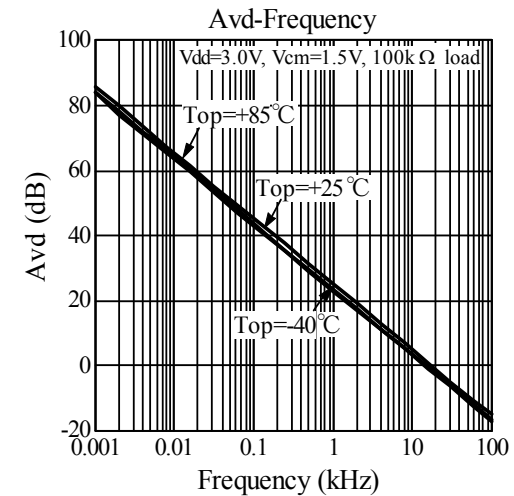
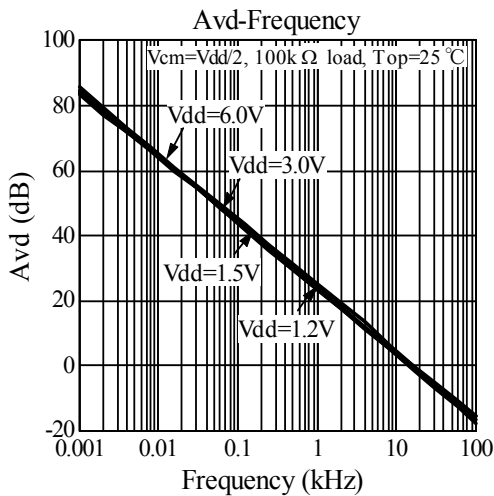
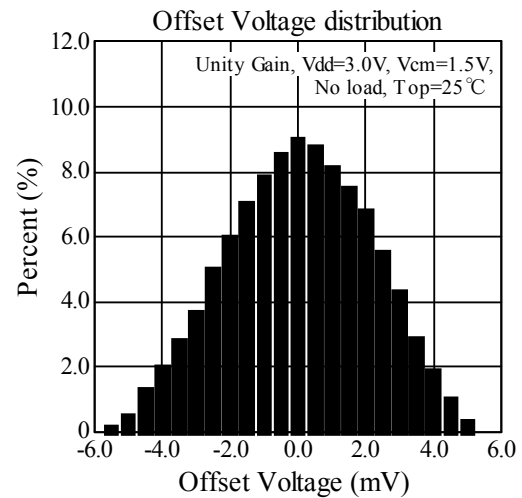
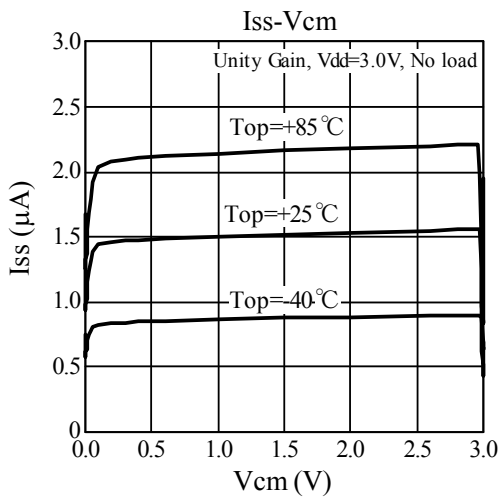
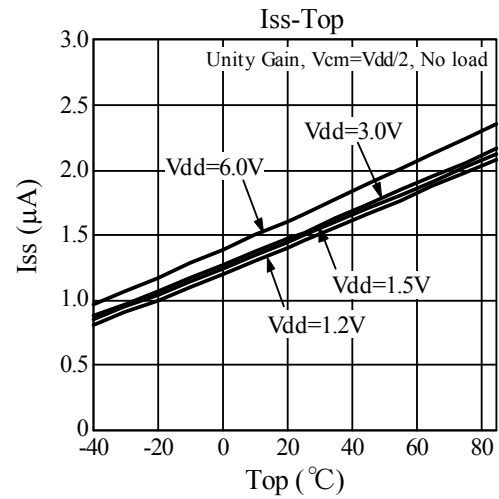
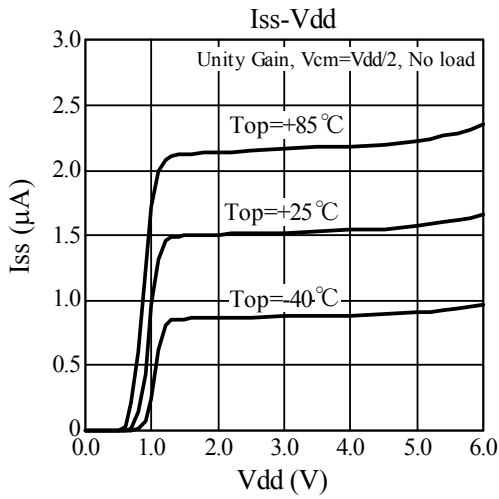

ELM822xA 1.5 μ A Very low power CMOS operational amplifier

<http://www.elm-tech.com>

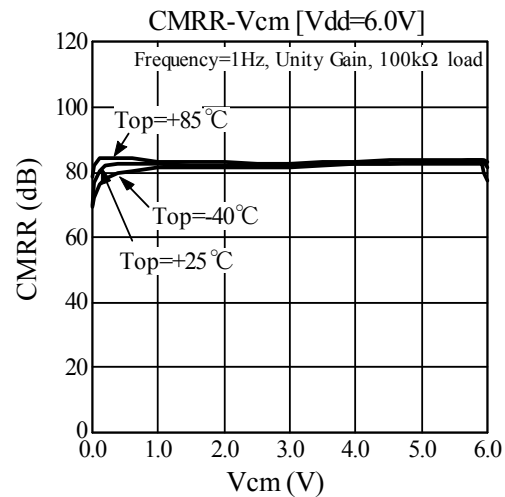
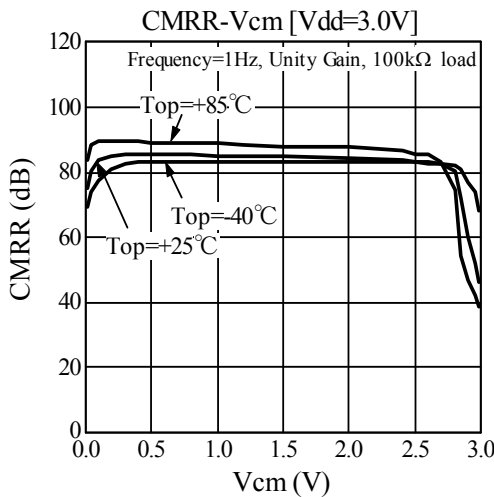
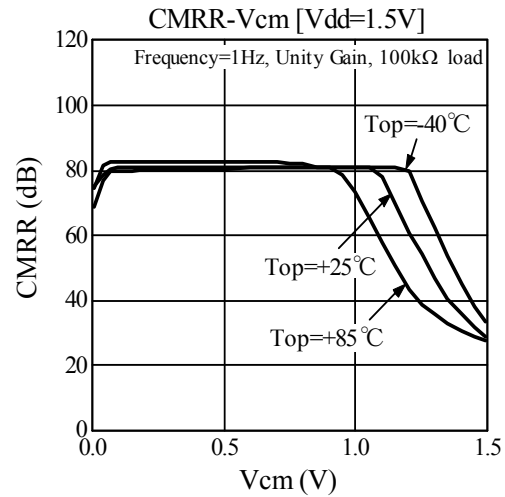
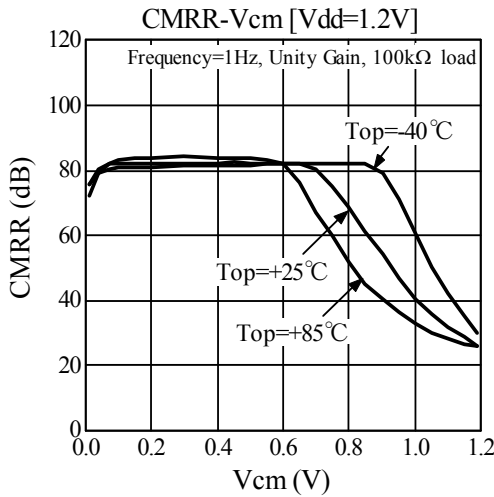
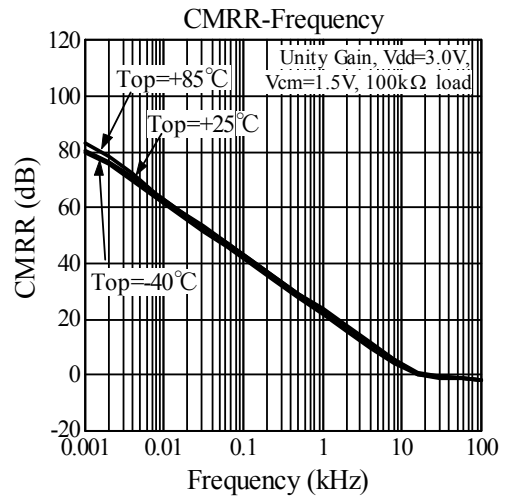
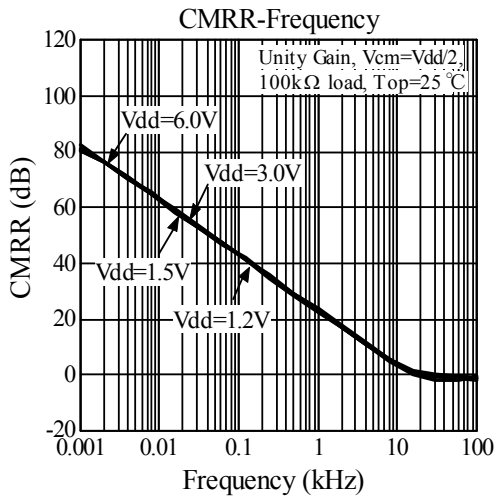

ELM822xA 1.5 μ A Very low power CMOS operational amplifier

<http://www.elm-tech.com>

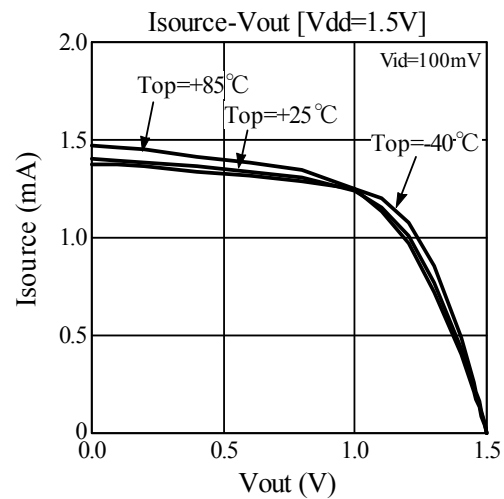
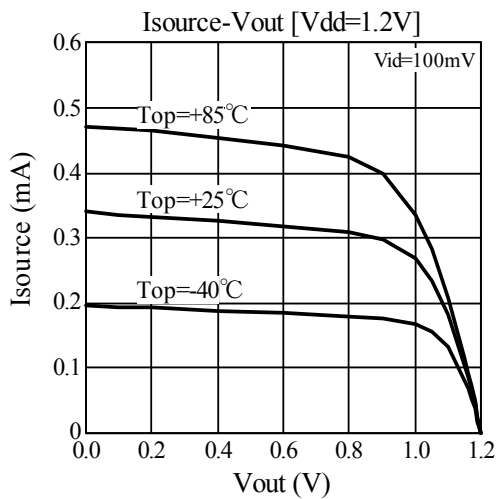
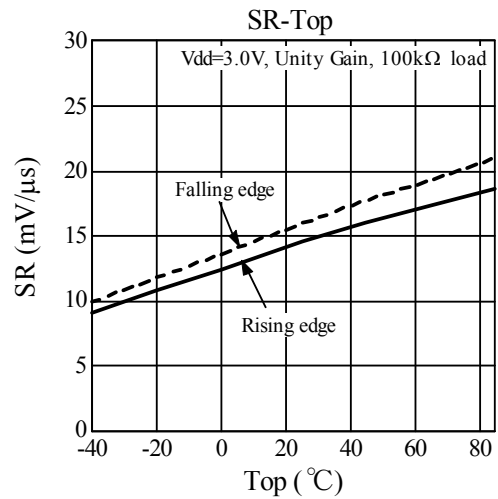
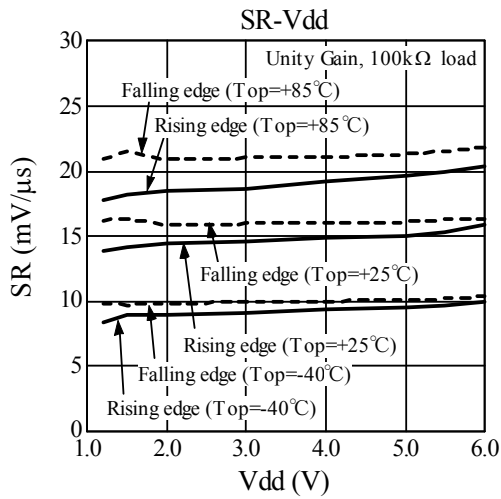
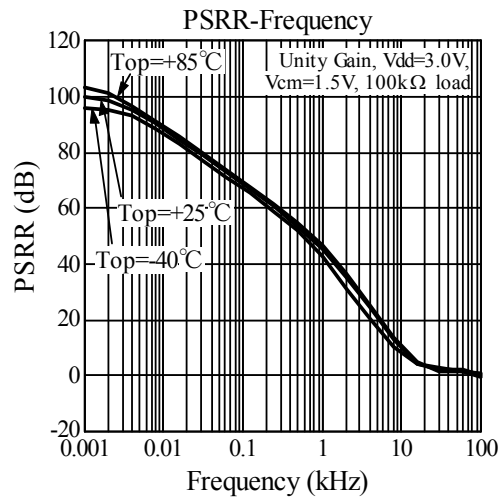
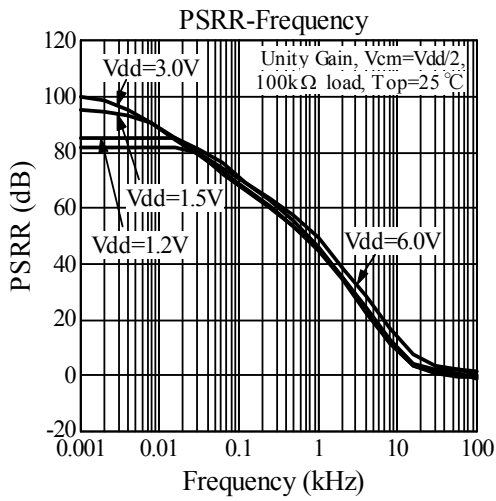

ELM822xA 1.5 μ A Very low power CMOS operational amplifier

<http://www.elm-tech.com>

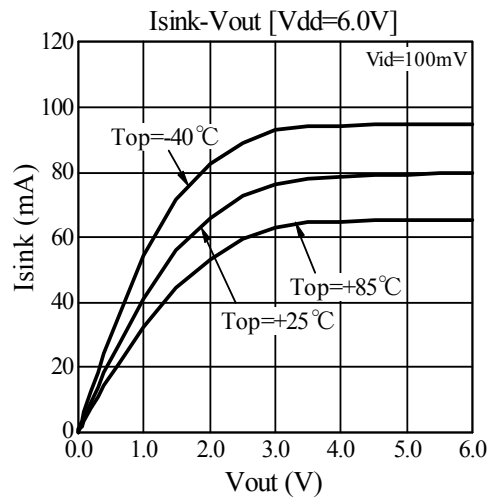
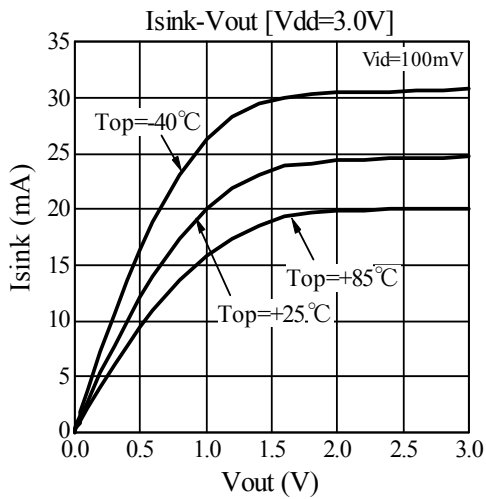
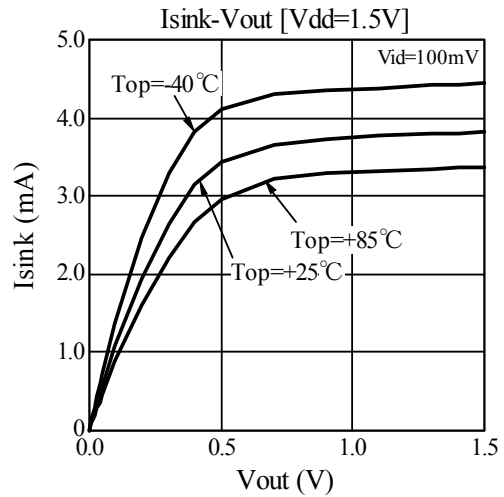
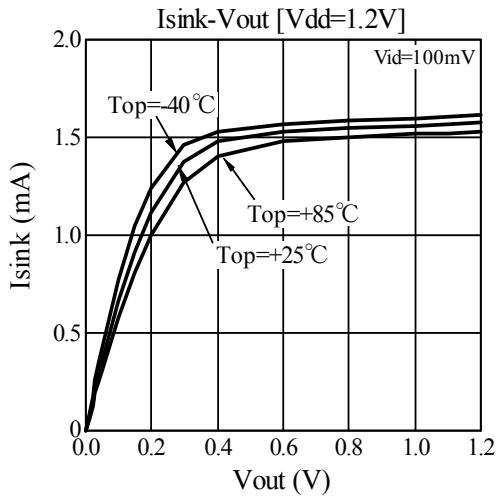
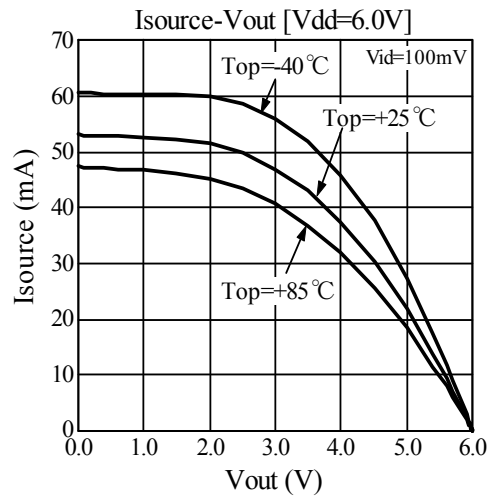
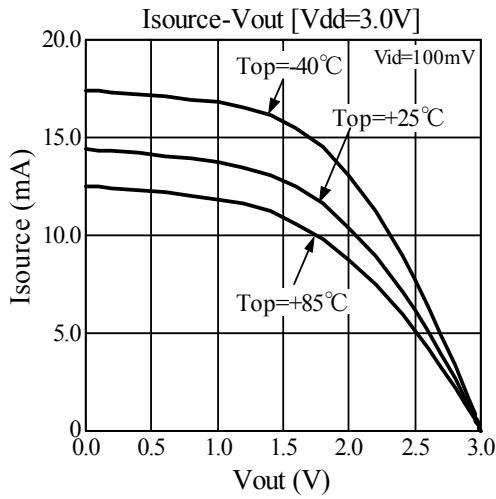

ELM822xA 1.5 μ A Very low power CMOS operational amplifier

<http://www.elm-tech.com>

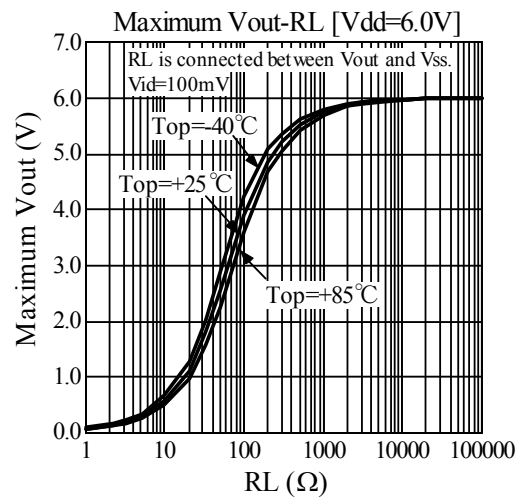
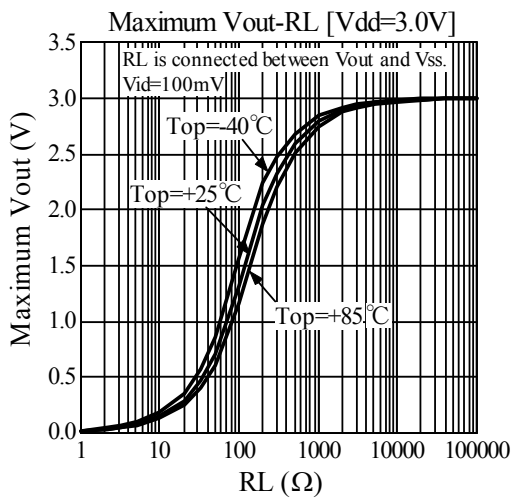
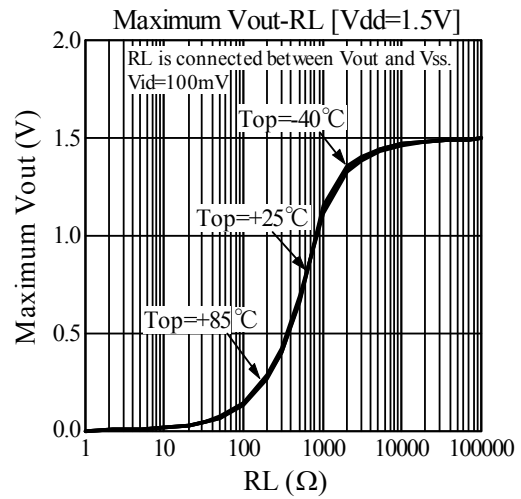
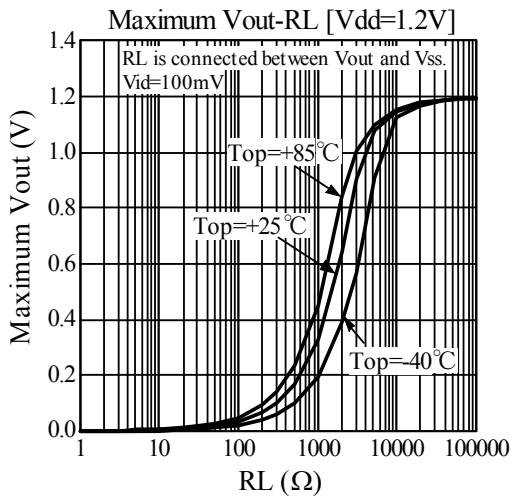
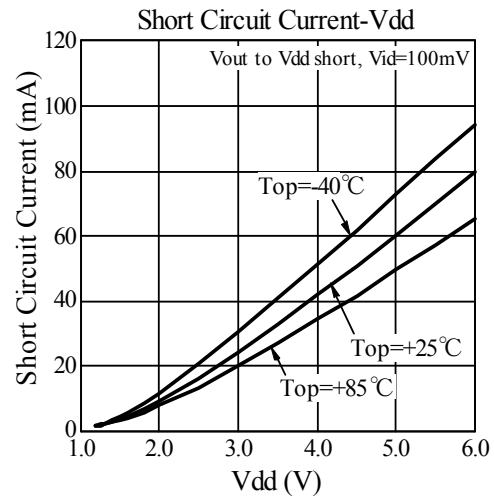
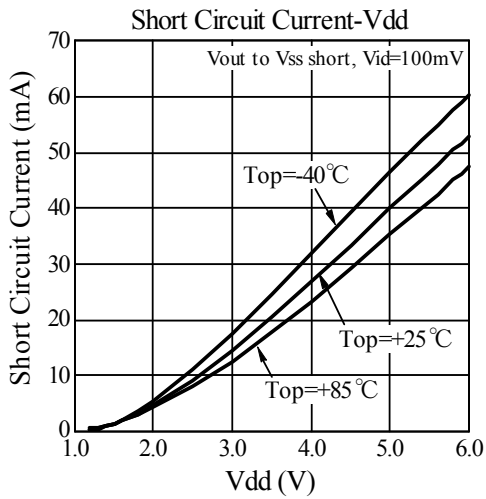

ELM822xA 1.5 μ A Very low power CMOS operational amplifier

<http://www.elm-tech.com>

